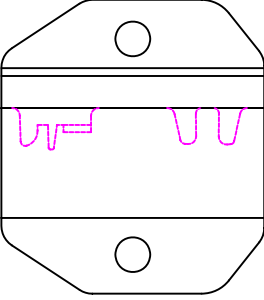
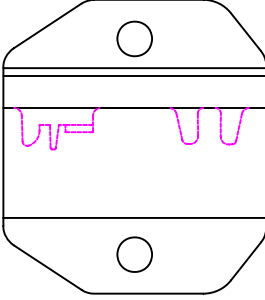
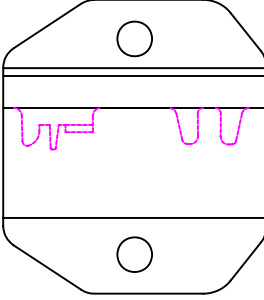
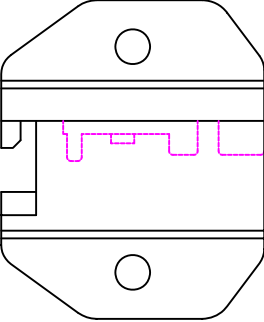
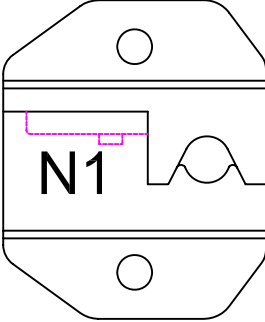

Die Set No.	1404
	
Specification	RJ-22 ,2 & 4 position handset modular plugs
Crimping Cable size	

Die Set No.	1406
	
Specification	RJ-11 ,2,4 & 6 position modular plugs
Crimping Cable size	

Die Set No.	1406D
	
Specification	RJ-11DEC MMJ 6 position modular plugs with an offset release tab
Crimping Cable size	

Die Set No.	1406T
	
Specification	RJ-11, 6 position SHIELDED plugs
Crimping Cable size	

Die Set No.	1406N1
	
Specification	RJ-11 , 6 position modular plugs , fully Shield CAT.5
Crimping Cable size	

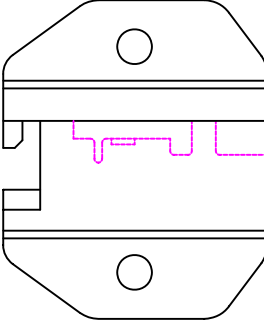
Die Set No.	1408
	
Specification	RJ-45 , 8 position Keyed or nonkeyed modular plugs (excluding AMP)
Crimping Cable size	

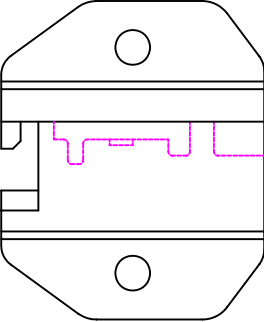
Die Set No.	1408A
	
Specification	AMP RJ-45, 8 position modular plugs Primary strain reliever crimp bar is located further back on die/ modular plugs
Crimping Cable size	

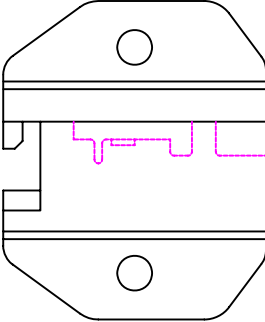
Die Set No.	1408G
	
Specification	RJ-45, 8 position SHIELDED plugs
Crimping Cable size	

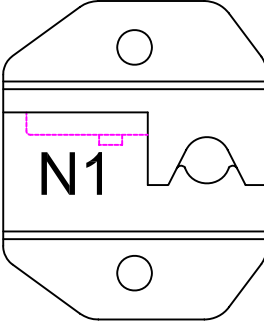
Die Set No.	1408N1
	
Specification	RJ-45 , 8 position modular plugs , fully Shield CAT.5
Crimping Cable size	